

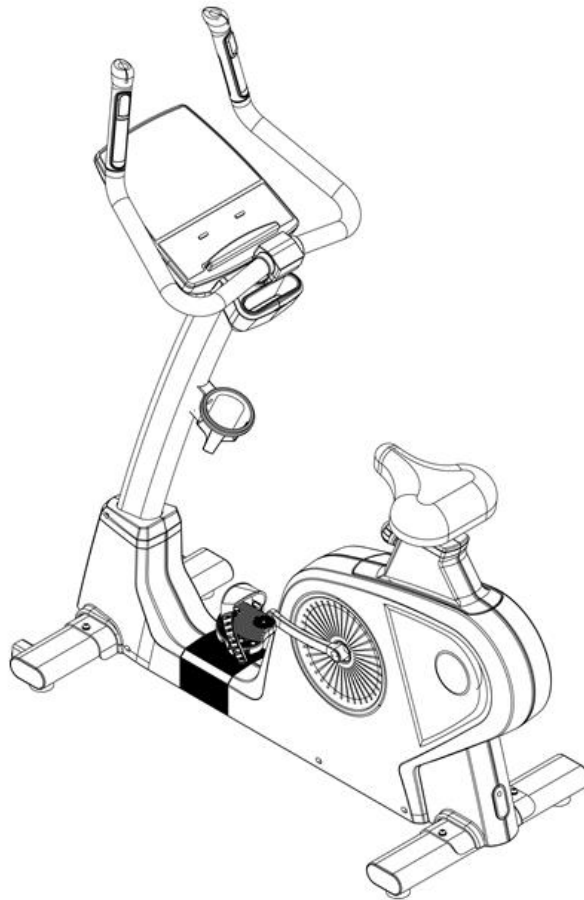

USER MANUAL – EN

IN 16662 Exercise Bike inSPORTline Gemini B200







CONTENTS





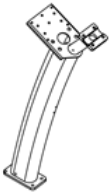

- SAFETY PRECAUTIONS..... 3
- PARTS LIST 4
- HARDWARE AND TOOLS..... 6
- ASSEMBLY STEPS 7
- OPERATION INSTRUCTIONS 10
 - DISPLAY 10
 - DISPLAY AND START-UP OF BOOT WINDOW 10
- KEY FUNCTIONS 10
- PROGRAM FUNCTIONS..... 11
 - PROGRAM MODE (P1~P12 PROGRAM)..... 11
 - MANUAL MODE 11
 - USER MODE 12
 - HRC MODE..... 13
 - WATTS MODE..... 14
- PROGRAM GRAPHS..... 15
- TERMS AND CONDITIONS OF WARRANTY, WARRANTY CLAIMS..... 16

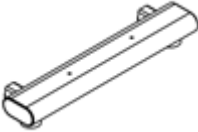
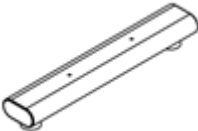
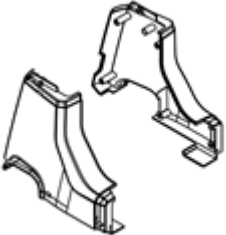
SAFETY PRECAUTIONS

- Read this manual carefully before first use and retain it for future reference.
- Follow all warnings and precautions and use it only according to this manual.
- To reduce risk of an electric shock, always unplug this product from electric outlet immediately after usage and before cleaning or maintenance.
- Pay attention while plugging it in to avoid burns.
- First step on this machine, then start it to use it safely.
- If you don't use it, switch it off and unplug from electric outlet.
- Keep it away from children and pets. Never let children unattended near this device. It is not a toy.
- People with physical or psychical impairment or people with lack of experiences may use it only under adult supervision.
- Exercise reasonably. Never overrate your skills. Improper exercising can result in serious injury. Consult your physician before starting any workout.
- Use it only for intended purpose and don't do any improper modification.
- Never operate it, if the cord or plug is damaged or if it doesn't work properly. Never drop it into water. For repair contact professional service.
- Never use the cord as handle.
- Keep the cord away from fire or heated surface.
- Never use it, if air vents are blocked. Keep them free of hair, dirt etc.
- Never put any object into sockets and compartments.
- Don't use it outdoors.
- Put it only on a flat, clean and solid surface. For higher safety keep a clearance round this device of at least 0.6 m.
- Don't use it in places, where there is aerosol (spray) in air or in places with lack of oxygen.
- Before turning it off, turn all controls off and the remove the plug from outlet.
- Use only properly grounded outlet.
- Check it regularly for damage or wearing. Check that all bolts and nuts are properly tightened. Never use damaged or worn product.
- Wear appropriate clothes and sports shoes. Avoid too loose dress that can be easily caught in machine.
- No adjustable part should protrude and obstruct user movements.
- Brake system is controlled by the speed under watt mode. In other mode, it doesn't depend on the speed.
- The battery should be charged per month.
- Flywheel weight: 8.1 kg
- **Weight limit:** 140 kg
- **Category:** SA (according to EN957 norm) suitable for commercial use.
- **WARNING!** The heart rate frequency monitoring may not be completely accurate. Overexertion during training can lead to a serious injury or even death. If you start to feel faint, stop the exercise immediately.

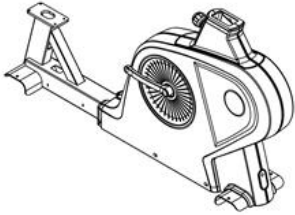
PARTS LIST

Sign	Picture	Description
A		Console mast
B		Console set
C		Console rear decoration cover
D		Holder accessory
E		Console front cover (L/R)
F		Front stabilizer set
G		Rear stabilizer set
H		Main frame front cover (L/R)

I		Console mast decoration cover (L/R)
J		Handlebar set
K		Main frame set
L		Seat set
M		Seat pad
N		Middle cover
O		Pedal set (L/R)

HARDWARE AND TOOLS

Item	Description	Qty
K01	Truss inner hex screw M8xP1.25x25	4
K02	Spring washer M8	4
K03	Washer $\varnothing 8 \times \varnothing 16 \times 1.5t$	4
K04	CKS inner hex screw M8xP1.25x20	4
K05	Washer $\varnothing 8 \times \varnothing 12 \times 1.0t$	4
K06	CKS inner hex screw M8xP1.25x20	4
K07	Spring washer M8	4
K08	Truss cross screw M5xP0.8x10	4
K09	Truss cross screw M5xP0.8x12	2
K10	Truss cross self-tapping screw $\varnothing 4 \times 10$	2
K11	Truss cross self-tapping screw $\varnothing 4 \times 20$	3
K12	Truss cross self-tapping screw $\varnothing 4 \times 16$	12
K13	L-shaped hex wrench + cross opener 5 mm	1
K14	Opening wrench 13 mm + 15 mm	1
K15	L-shaped hex wrench + cross opener 6 mm	1

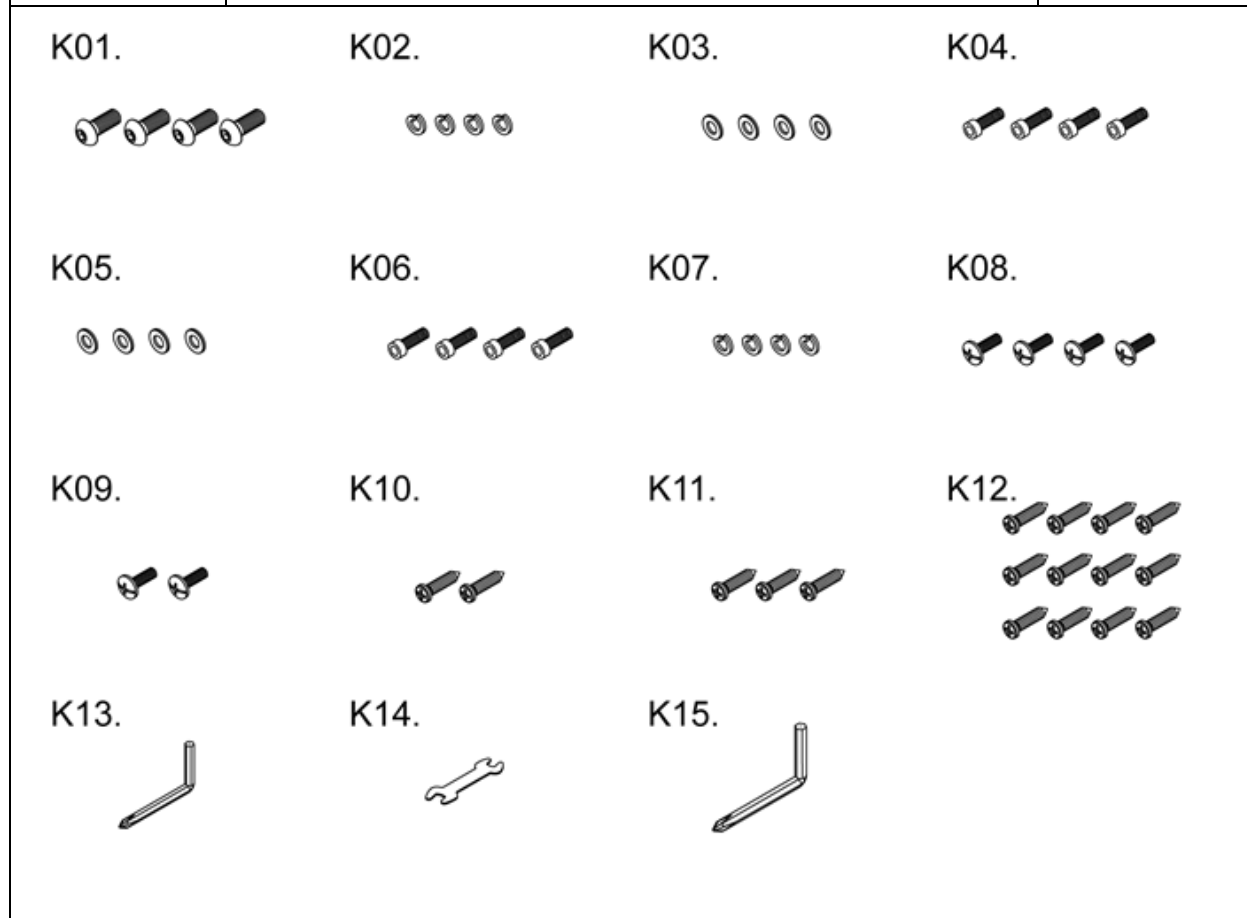

ASSEMBLY STEPS

STEP 1

- Fix and fasten main frame set (K) and front and rear stabilizer (F, G) using screw (K01), spring washer (K02) and washer (K03).
- Connect the wires as in picture and install the console mast (A) to the main frame set (K) using screw (K04), washer (K05) to secure it. Don't press wires.
- Take off the screw nut and washer on the seat pad (M). Then install the seat pad (M) to the seat set (L). Fix and lock it with the screw nut a washer that you took off first.
- After pulling up the pop pin, insert the seat set (L) into the main frame and assemble the left and right pedal (O). Distinguish the left and the right pedal. They are signed with L-left and R-right on the bottom.

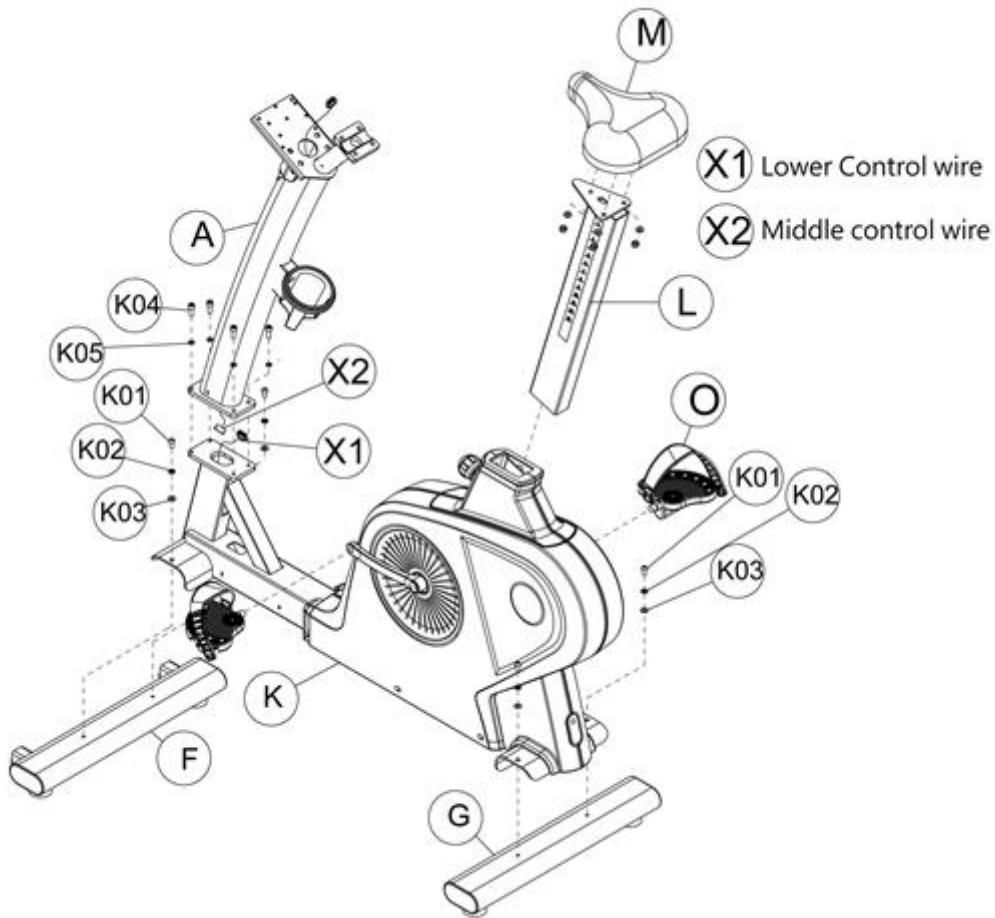

STEP 2

- Make the wires of the handlebar set (J) cross the console mast and fasten handlebar set (J) and the control tube with screw (K06) and washer (K07). Don't press the wires.

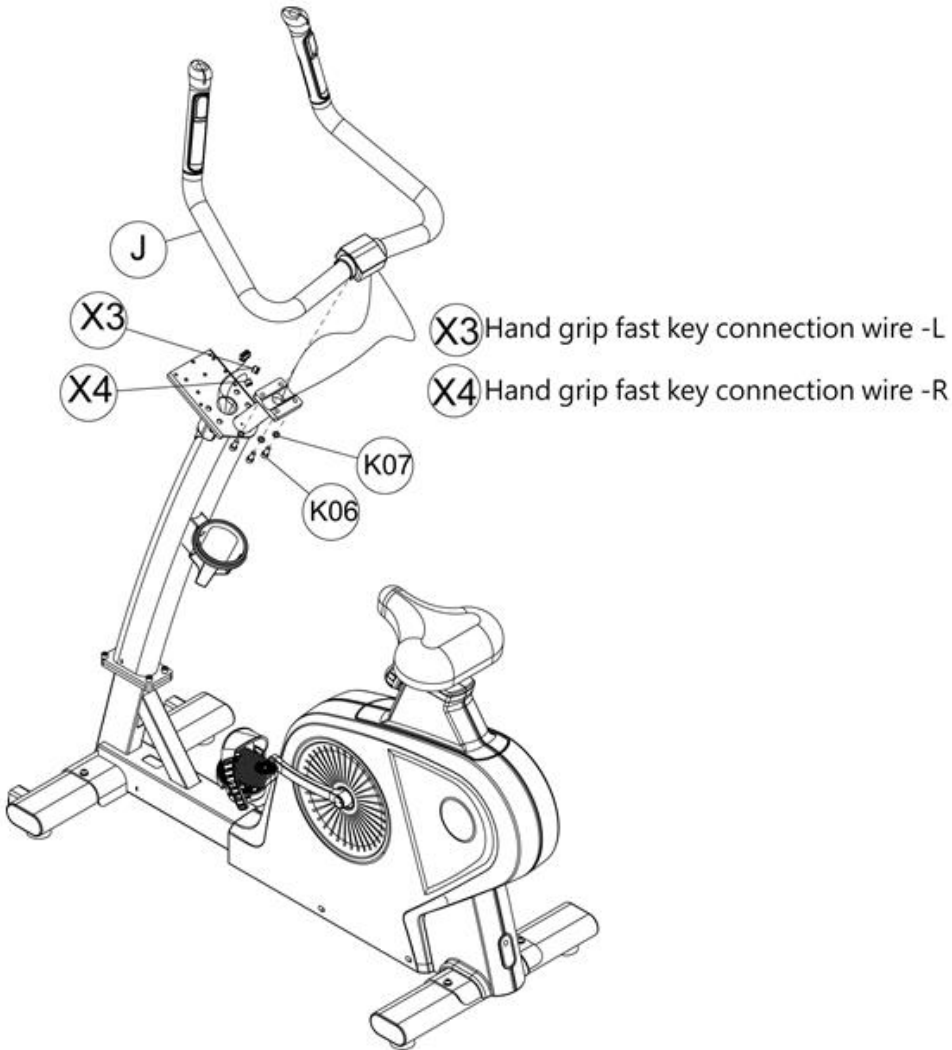

STEP 3

- Connect the console (B) with the wires of the console mast. Thereafter secure it with screw (K08).
- Fasten the console front decoration cover (E) using screw (K09) and then fasten the accessory holder (D) with screw (K10). Then fix and fasten the console lower decoration cover (C) with screw (K11).
- Next, fix the main frame front cover (H) to the main frame using screw (K12). Then fix the console mast decoration cover (I) with screw (K12).

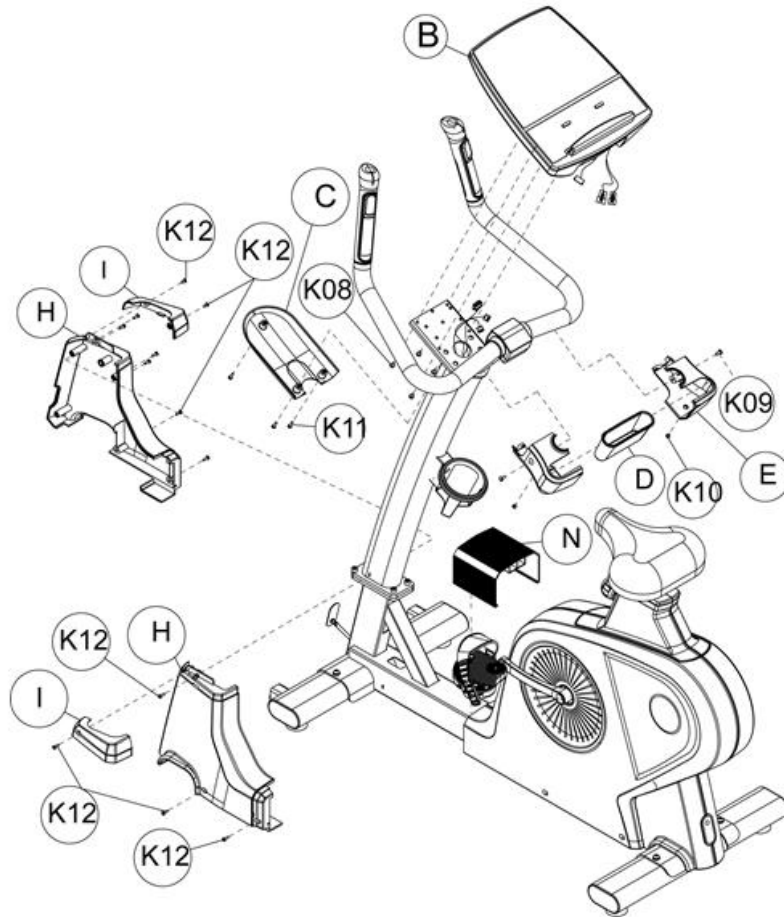

OPERATION INSTRUCTIONS

DISPLAY

This is LED display console. Functions include: RPM, SPEED, TIME, CALORIES, DISTANCE, WATTS, LEVEL. Dot matrix displays PROGRAM graph.

DISPLAY AND START-UP OF BOOT WINDOW

STANDBY MODE

After the console has lighted up, dot matrix displays METRIC (or British unit) KM (or ML). to U1 graphic. There are U1-U4 that can be selected.





SLEEP MODE

When the console is in the standby mode and RPM is lower than 30 or there is no key action for 15 seconds, the program enters the prompt mode for 16 seconds. After 16 sound signals it enters the sleep mode. During the period of 16 seconds, if the RPM will be over 30 or if some key is pushed, the timing program (16 seconds) will be cancelled and the console comes back to the standby mode.

In the setting page (user setting, weight setting and program setting), if RPM is less than 30 for 10 seconds, the program will be stopped and returns to the standby mode. If the RPM is still under 30 or there is no key operation for 5 seconds, program will enter the prompt for 16 seconds and after 16 sound signals it enters the sleep mode. During the timing period (16 seconds) if RPM is over 30 or some key is pushed, the timing will be cancelled and console returns back to the standby mode.

When operating all the programs, if the RPM has not reached value 30, dot matrix display shows rolling string of RPM ↑ for 5 seconds. After that, if the RPM is still not 30, the dot matrix will show the rolling string of PAUSE for 5 seconds.

KEY FUNCTIONS

	START	<ul style="list-style-type: none">Press the key and the program will start the QUICK START function directly.
	RECOVERY	<ul style="list-style-type: none">During workout hold the hand pulse sensor until PULSE window shows the heart rate value. Then push RECOVERY. Then the display stops and the TIME window start counting down for 60 seconds. After it reaches zero, it displays result of your heart rate recovery status (F1-F6). F1 is the best result of heart rate recovery status.
	PAUSE	<ul style="list-style-type: none">If the exercise has been started, push PAUSE to pause it.If you push it during program setting process, you go back to the program select page for reworking.
	STOP	<ul style="list-style-type: none">Push STOP to stop it. You can use the ENTER key to switch the display screen: SPEED-TIME-DISTANCE/RPM-CALORIES-WATTS.
	ENTER	<ul style="list-style-type: none">During program setting, push ENTER to confirm selection and to go to the next page.

	DIRECTION	<ul style="list-style-type: none"> • These keys are used for increasing or decreasing various values (weight, height, age, sex, pulse, time) and selection of functional modes (watt, HRC, user, program, manual) or for resistance adjusting.
---	-----------	---

PROGRAM FUNCTIONS

PROGRAM MODE (P1~P12 PROGRAM)

- Pres the direction key to select program P1-P12.
- Press ENTER to go into target value setting page.
- After pushing ENTER, the TIME indicator lights up and the LED indicator light shines on the display of TIME. The initial value of TIME is: 0:00. Use direction keys to set TIME.
- After setting the TIME push ENTER. The DISTANCE indicator lights up and the LED indicator light shines on the display of DISTANCE. The initial distance value is: 0.0. Use direction keys to set DISTANCE.
- After setting the DISTANCE push ENTER. The CALORIES indicator lights up and the LED indicator light shines on the display of CALORIES. The initial calorie value is: 0. Use direction keys to set CALORIES.
- TIME-DISTANCE-CALORIES can be set in a cycle. After the target values of time, distance and calories are set in, push START to start operations.
- During workout push ENTER to switch, fix and display the SPEED-TIME-DISTANCE/RPM-CALORIES-WATTS screen.
- During exercise press PAUSE and the program will pause. The TIME/DISTANCE/CALORIES display will show motion data by turns.
- In pause, if you want to continue previous workout, push START and the program will continue with accumulated data of TIME/DISTANCE/CALORIES as it was before pausing.
- Push STOP to stop the program. Push it again to clean exercise data and to go back to the main program selecting page (MANUAL/PROGRAM/USER/HRC/WATTS).

DOT MATRIX MESSAGES:

During exercising, if RPM has not reached the value of 30, the screen shows twice rolling string RPM↑ for 5 seconds. After this message, if the RPM is still not reached, the program will be paused and screen shows twice rolling string of PAUSE for 5 seconds.

MANUAL MODE

- Push direction keys and select MANUAL.
- Pres ENTER to go into target value setting page.
- After pushing ENTER, the TIME indicator lights up and the LED indicator light shines on the display of TIME. The initial value of TIME is: 0:00. Use direction keys to set TIME.
- After setting the TIME push ENTER. The DISTANCE indicator lights up and the LED indicator light shines on the display of DISTANCE. The initial distance value is: 0.0. Use direction keys to set DISTANCE.

- After setting the DISTANCE push ENTER. The CALORIES indicator lights up and the LED indicator light shines on the display of CALORIES. The initial calorie value is: 0. Use direction keys to set CALORIES.
- TIME-DISTANCE-CALORIES can be set in a cycle. After the target values of time, distance and calories are set in, push START to start operations.
- During workout push ENTER to switch, fix and display the SPEED-TIME-DISTANCE/RPM-CALORIES-WATTS screen.
- During exercise press PAUSE and the program will pause. The TIME/DISTANCE/CALORIES display will show motion data by turns.
- In pause, if you want to continue previous workout, push START and the program will continue with accumulated data of TIME/DISTANCE/CALORIES as it was before pausing.
- Push STOP to stop the program. Push it again to clean exercise data and to go back to the main program selecting page (MANUAL/PROGRAM/USER/HRC/WATTS).

DOT MATRIX MESSAGES:

During exercising, if RPM has not reached the value of 30, the screen shows twice rolling string RPM↑ for 5 seconds. After this message, if the RPM is still not reached, the program will be paused and screen shows twice rolling string of PAUSE for 5 seconds.

USER MODE

- Push direction keys and select USER.
- Pres ENTER to go into target value setting page.
- After pushing ENTER, the TIME indicator lights up and the LED indicator light shines on the display of TIME. The initial value of TIME is: 0:00. Use direction keys to set TIME.
- After setting the TIME push ENTER. The DISTANCE indicator lights up and the LED indicator light shines on the display of DISTANCE. The initial distance value is: 0.0. Use direction keys to set DISTANCE.
- After setting the DISTANCE push ENTER. The CALORIES indicator lights up and the LED indicator light shines on the display of CALORIES. The initial calorie value is: 0. Use direction keys to set CALORIES.
- TIME-DISTANCE-CALORIES can be set in a cycle. After the target values of time, distance and calories are set in, push START to start operations.

If the user wants to do operating program of graphical editing:

- Enter the USER program. The TIME indicator lights up and the LED indicator light shines on the display of TIME. The initial value of TIME is: 0:00.
- For graph editing, push ENTER and hold for 3 seconds. Then the first row on the dot matrix will be flicked. At the TIME display chart will show code S-1 to show editing.
- Push direction keys to set LEVEL. After complete setting is confirmed, press ENTER to set program level for the next row.
- When entering the LEVEL setting but failed on setting, the user can press ENTER and convert to the next operation setting program. There are S-1 ~ S-16 locations in total for setting. After setting these locations, this device converts to the setting program of TIME for operation.
- During workout push ENTER to switch, fix and display the SPEED-TIME-DISTANCE/RPM-CALORIES-WATTS screen.

- During exercise press PAUSE and the program will pause. The TIME/DISTANCE/CALORIES display will show motion data by turns.
- In pause, if you want to continue previous workout, push START and the program will continue with accumulated data of TIME/DISTANCE/CALORIES as it was before pausing.
- Push STOP to stop the program. Push it again to clean exercise data and to go back to the main program selecting page (MANUAL/PROGRAM/USER/HRC/WATTS).

DOT MATRIX MESSAGES:

During exercising, if RPM has not reached the value of 30, the screen shows twice rolling string RPM↑ for 5 seconds. After this message, if the RPM is still not reached, the program will be paused and screen shows twice rolling string of PAUSE for 5 seconds.

HRC MODE

- Push direction keys to select HRC.
- Push ENTER to go into target value setting page.
- After pushing ENTER, the HEIGHT indicator lights up and the dot matrix display will show HEIGHT. The initial height value is: 170. Use direction keys to set the height.
- After setting the HEIGHT, push ENTER and the AGE indicator lights up and the dot matrix displays AGE. The initial age value is: 30. Use direction keys to set age.
- After setting the AGE, push ENTER and the SEX indicator lights up and the dot matrix displays GENDER. The initial sex value is: M as male (F as female). Use direction keys to set sex.
- After setting the SEX, push ENTER and the TARGET 90%, 75%, 55% indicator lights up and there is displayed the initial value at the PULSE. Use direction keys to select the target value. TARGET allows the user to set the target heart rate value using direction keys. The initial value of 90%, 75% and 55% depends on height, age and sex setting.
- After completing the PULSE setting, press ENTER. The TIME indicator lights up and the LED indicator light shines on the display of TIME. The initial time value is 0:00. Use direction keys to set TIME.
- After setting the TIME push ENTER. The DISTANCE indicator lights up and the LED indicator light shines on the display of DISTANCE. The initial distance value is: 0.0. Use direction keys to set DISTANCE.
- After setting the DISTANCE push ENTER. The CALORIES indicator lights up and the LED indicator light shines on the display of CALORIES. The initial calorie value is: 0. Use direction keys to set CALORIES.
- TIME-DISTANCE-CALORIES can be set in a cycle. After the target values of time, distance and calories are set in, push START to start operations.
- During workout push ENTER to switch, fix and display the SPEED-TIME-DISTANCE/RPM-CALORIES-WATTS screen.
- During exercise press PAUSE and the program will pause. The TIME/DISTANCE/CALORIES display will show motion data by turns.
- In pause, if you want to continue previous workout, push START and the program will continue with accumulated data of TIME/DISTANCE/CALORIES as it was before pausing.
- Push STOP to stop the program. Push it again to clean exercise data and to go back to the main program selecting page (MANUAL/PROGRAM/USER/HRC/WATTS).

A. OPERATION OF WARM UP FUNCTION

- Resistance is pre-set at level 1. Heart Rate Control function will automatically work after 1 min.
- The user can still use direction keys to adjust the resistance.

B. OPERATING PROGRAM OF HEART RATE CONTROL FUNCTION

- In the program comparison between the actual heart rate and pre-set heart rate (55%, 75%, 90%/TARGET) will be conducted once every 10 seconds.
- If the program fails in detection of actual heart rate, the program will be paused and the resistance will not be increased. There will be displayed "P" on the PULSE display.
- The user can use direction keys to increase or decrease the resistance.
- When the actual heart rate is lower than the pre-set heart rate for 4 mins., the program will automatically increase the resistance. Each time increment is 1 level. The maximum for increasing is the level 16.
- When the actual heart rate is higher than the pre-set heart rate for 4 mins., the program will automatically reduce the resistance. Each time decrement is 1 level. The minimum for decreasing is the level 1.
- If actual heart rate reaches the pre-set heart rate value for consecutive 3 mins., or pre-set time is over, the program stops automatically the Heart Rate Control function and enters the COOL DOWN.

C. COOL DOWN (for 1 min. after Heart Rate Control)

- When starting the 1-minute Cool Down Function, the program gives a long sound (beep) and the dot matrix display shows COOL. The TIME display will start counting down for 1 minute.
- In the COOL DOWN function, the resistance level will be on 1 and all the data will be continuing from previous heart rate control. They continue to be used and accumulated.
- In this function only the key STOP/RESET can be used.

WATTS MODE

- Push direction keys and select WATTS.
- Press ENTER to go into target value setting page.
- After pushing ENTER, the WATTS indicator lights up and the LED indicator light shines on the display of WATTS. The initial value of WATTS is: 120. Use direction keys to set WATTS.
- After setting the WATTS push ENTER. The TIME indicator lights up and the LED indicator light shines on the display of TIME. The initial time value is: 0:00. Use direction keys to set TIME.
- After setting the TIME push ENTER. The DISTANCE indicator lights up and the LED indicator light shines on the display of DISTANCE. The initial distance value is: 0.0. Use direction keys to set DISTANCE.
- After setting the DISTANCE push ENTER. The CALORIES indicator lights up and the LED indicator light shines on the display of CALORIES. The initial calorie value is: 0. Use direction keys to set CALORIES.
- TIME-DISTANCE-CALORIES can be set in a cycle. After the target values of time, distance and calories are set in, push START to start operations.
- During workout push ENTER to switch, fix and display the SPEED-TIME-DISTANCE/RPM-CALORIES-WATTS screen.

- During exercise press PAUSE and the program will pause. The TIME/DISTANCE/CALORIES display will show motion data by turns.
- In pause, if you want to continue previous workout, push START and the program will continue with accumulated data of TIME/DISTANCE/CALORIES as it was before pausing.
- Push STOP to stop the program. Push it again to clean exercise data and to go back to the main program selecting page (MANUAL/PROGRAM/USER/HRC/WATTS).

DOT MATRIX MESSAGES:

During exercising, if RPM has not reached the value of 30, the screen shows twice rolling string RPM↑ for 5 seconds. After this message, if the RPM is still not reached, the program will be paused and screen shows twice rolling string of PAUSE for 5 seconds.

PROGRAM GRAPHS

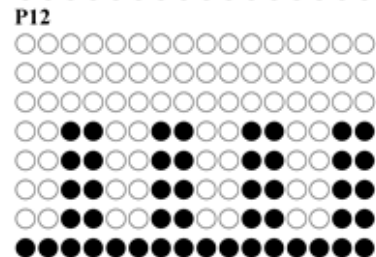
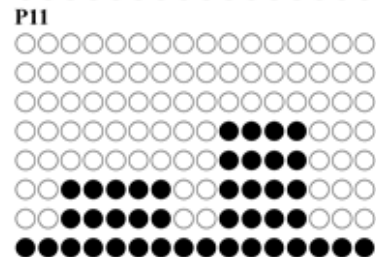
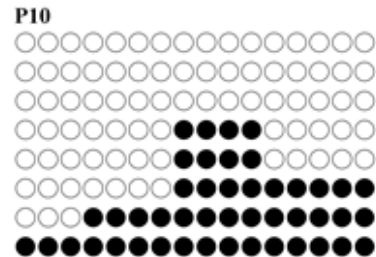
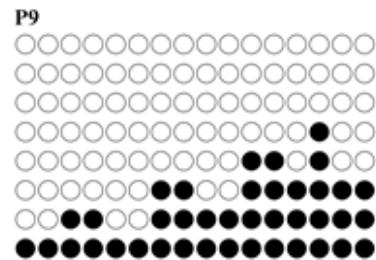
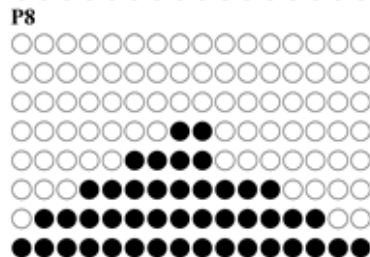
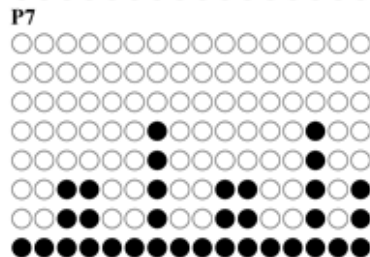
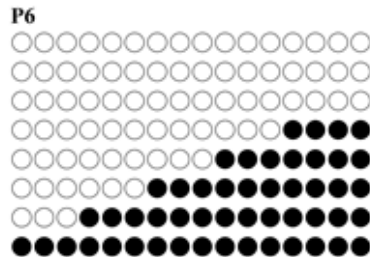
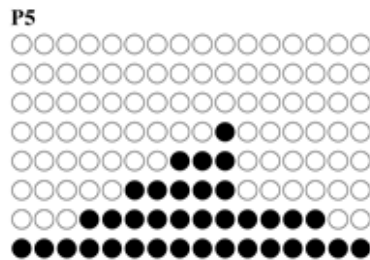
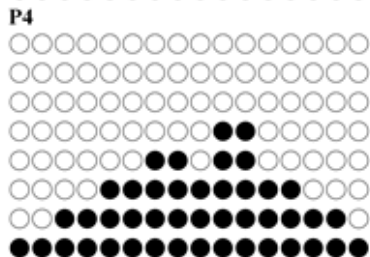
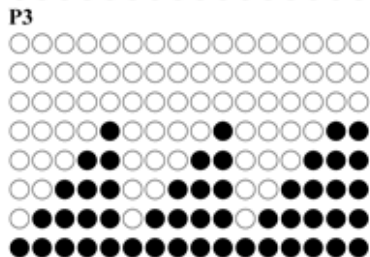
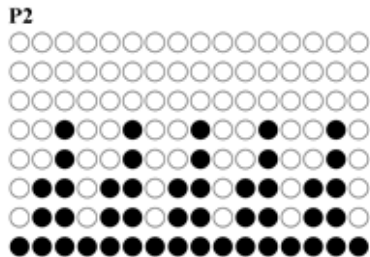
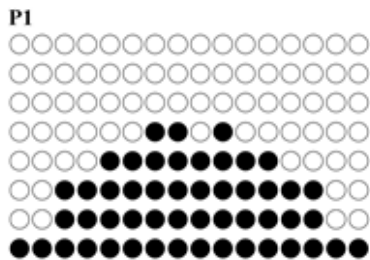
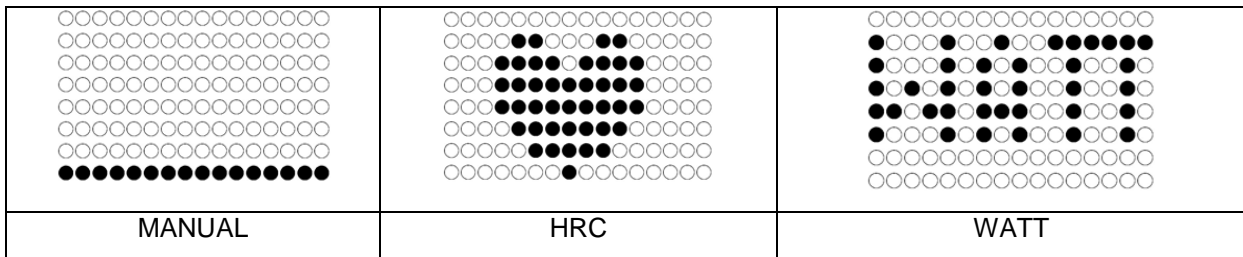

TERMS AND CONDITIONS OF WARRANTY, WARRANTY CLAIMS

General Conditions of Warranty and Definition of Terms

All Warranty Conditions stated hereunder determine Warranty Coverage and Warranty Claim Procedure. Conditions of Warranty and Warranty Claims are governed by Act No. 40/1964 Coll. Civil Code, Act No. 513/1991 Coll., Commercial Code, and Act No. 634/1992 Coll., Consumer Protection Act, as amended, also in cases that are not specified by these Warranty rules.

The seller is SEVEN SPORT s.r.o. with its registered office in Borivojova Street 35/878, Prague 13000, Company Registration Number: 26847264, registered in the Trade Register at Regional Court in Prague, Section C, Insert No. 116888.

According to valid legal regulations it depends whether the Buyer is the End Customer or not.

“The Buyer who is the End Customer” or simply the “End Customer” is the legal entity that does not conclude and execute the Contract in order to run or promote his own trade or business activities.

“The Buyer who is not the End Customer” is a Businessman that buys Goods or uses services for the purpose of using the Goods or services for his own business activities. The Buyer conforms to the General Purchase Agreement and business conditions to the extent specified in the Commercial Code.

These Conditions of Warranty and Warranty Claims are an integral part of every Purchase Agreement made between the Seller and the Buyer. All Warranty Conditions are valid and binding, unless otherwise specified in the Purchase Agreement, in the Amendment to this Contract or in another written agreement.

Warranty Conditions

Warranty Period

The Seller provides the Buyer a 24 months Warranty for Goods Quality, unless otherwise specified in the Certificate of Warranty, Invoice, Bill of Delivery or other documents related to the Goods. The legal warranty period provided to the Consumer is not affected.

By the Warranty for Goods Quality, the Seller guarantees that the delivered Goods shall be, for a certain period of time, suitable for regular or contracted use, and that the Goods shall maintain its regular or contracted features.

The Warranty does not cover defects resulting from (if applicable):

- User's fault, i.e. product damage caused by unqualified repair work, improper assembly, insufficient insertion of seat post into frame, insufficient tightening of pedals and cranks
- Improper maintenance
- Mechanical damages
- Regular use (e.g. wearing out of rubber and plastic parts, moving mechanisms, joints etc.)
- Unavoidable event, natural disaster
- Adjustments made by unqualified person
- Improper maintenance, improper placement, damages caused by low or high temperature, water, inappropriate pressure, shocks, intentional changes in design or construction etc.

Warranty Claim Procedure

The Buyer is obliged to check the Goods delivered by the Seller immediately after taking the responsibility for the Goods and its damages, i.e. immediately after its delivery. The Buyer must check the Goods so that he discovers all the defects that can be discovered by such check.

When making a Warranty Claim the Buyer is obliged, on request of the Seller, to prove the purchase and validity of the claim by the Invoice or Bill of Delivery that includes the product's serial number, or eventually by the documents without the serial number. If the Buyer does not prove the validity of the Warranty Claim by these documents, the Seller has the right to reject the Warranty Claim.

If the Buyer gives notice of a defect that is not covered by the Warranty (e.g. in the case that the Warranty Conditions were not fulfilled or in the case of reporting the defect by mistake etc.), the Seller is eligible to require a compensation for all the costs arising from the repair. The cost shall be calculated according to the valid price list of services and transport costs.

If the Seller finds out (by testing) that the product is not damaged, the Warranty Claim is not accepted. The Seller reserves the right to claim a compensation for costs arising from the false Warranty Claim.

In case the Buyer makes a claim about the Goods that is legally covered by the Warranty provided by the Seller, the Seller shall fix the reported defects by means of repair or by the exchange of the damaged part or product for a new one. Based on the agreement of the Buyer, the Seller has the right to exchange the defected Goods for a fully compatible Goods of the same or better technical characteristics. The Seller is entitled to choose the form of the Warranty Claim Procedures described in this paragraph.

The Seller shall settle the Warranty Claim within 30 days after the delivery of the defective Goods, unless a longer period has been agreed upon. The day when the repaired or exchanged Goods is handed over to the Buyer is considered to be the day of the Warranty Claim settlement. When the Seller is not able to settle the Warranty Claim within the agreed period due to the specific nature of the Goods defect, he and the Buyer shall make an agreement about an alternative solution. In case such agreement is not made, the Seller is obliged to provide the Buyer with a financial compensation in the form of a refund.



SEVEN SPORT s.r.o.

Registered Office:	Borivojova 35/878, 130 00 Praha 3, Czech Republic
Headquarters:	Delnicka 957, 749 01 Vitkov, Czech Republic
Warranty & Service Centre:	Cermenska 486, 749 01 Vitkov, Czech Republic
CRN:	26847264
VAT ID:	CZ26847264
Phone:	+420 556 300 970
E-mail:	eshop@insportline.cz reklamace@insportline.cz servis@insportline.cz
Web:	www.insportline.cz

SK

INSPORTLIN s.r.o.

Headquarters, Warranty & Service centre:	Elektricka 6471, 911 01 Trencin, Slovakia
CRN: 36311723	
VAT ID: SK2020177082	
Phone:	+421(0)326 526 701
E-mail:	objednavky@insportline.sk reklamacie@insportline.sk servis@insportline.sk
Web:	www.insportline.sk

Date of Sale:

Stamp and Signature of Seller: